

SERVICE MANUAL

LPH SERIES SYNTHESIZED PORTABLE RADIO



BENDIX/KING

TABLE OF CONTENTS

SECTION I GENERAL INFORMATION

Paragraph		Page
1.1	INTRODUCTION	1-1
1.2	DESCRIPTION	1-1
1.3	TECHNICAL CHARACTERISTICS	1-1
1.4	ACCESSORIES	1-2
1.5	LICENSE REQUIREMENTS	1-3
1.6	SERVICE INFORMATION	1-3
1.7	WARRANTY INFORMATION	1-3

SECTION II INSTALLATION AND PROGRAMMING

2.1	GENERAL INFORMATION	2-1
2.2	UNPACKING AND INSPECTING EQUIPMENT	2-1
2.3	PROGRAMMING	2-1
2.3.1	INTRODUCTION	2-1
2.3.2	REVIEWING THE PROGRAM IN A MASTER RADIO	2-1
2.3.3	PROGRAMMING A MASTER RADIO THROUGH THE INTERNAL KEYBOARD AND	2-3
2.3.4	CLONING A RADIO FROM A MASTER	2-8
2.3.5	SPECIAL CLONING INSTRUCTIONS	2-9
2.3.6	SCAN LIST AND PRIORITY CHANNEL CLONING	2-10
2.3.7	CLONING VIA RS 232 INTERFACE	2-10
2.3.8	SELECTING A TONE CODE GUARD™	2-10
2.3.9	SELECTING A DIGITAL CODE GUARD™	2-10
2.3.10	BATTERY REPLACEMENT	2-11

SECTION III OPERATION

3.1	INTRODUCTION	3-1
3.2	OPERATION	3-1
3.2.1	BASIC OPERATION	3-1
3.2.2	CODE GUARD™ OPERATION	3-1
3.2.3	TRANSMIT POWER	3-2
3.2.4	BUILT IN FEATURES	3-2
3.2.5	OPERATIONAL FEATURES AVAILABLE ON SELECT MODELS	3-2

SECTION IV THEORY OF OPERATION

4.1	INTRODUCTION	4-1
4.2	EQUIPMENT DESCRIPTION	4-1
4.3	THEORY OF OPERATION	4-1
4.3.1	RECEIVER	4-1
4.3.2	Transmitter	4-2
4.3.3	SYNTHESIZER	4-4
4.3.4	SYSTEMS AREA	4-5
4.3.5	PROGRAMMABLE FREQUENCY INCREMENTS	4-6

SECTION V MAINTENANCE

5.1	INTRODUCTION	5-1
5.2	TEST AND ALIGNMENT	5-1
5.2.1	TEST EQUIPMENT REQUIRED	5-1
5.2.2	STANDARD TEST SIGNAL	5-1
5.2.3	DISASSEMBLY/ASSEMBLY	5-1
5.2.4	TEST AND ALIGNMENT PROCEDURES	5-2
5.2.5	TROUBLESHOOTING	5-5

SECTION VI ILLUSTRATED PARTS LIST

Item	Page	
6-1	Final Assembly	6-9
6-2	Receiver Frame Assembly	6-15
6-3	Front Cover Assembly	6-23
6-4	Keyboard/Display Assembly	6-27
6-5	Receiver Board	6-31
6-6	5 Watt Transmitter Board	6-39
6-7	2 Watt Transmitter Board	6-47
6-8	2 Channel System Board	6-54
6-9	Keyboard/Display Board	6-61

LIST OF ILLUSTRATIONS

Figure	Page	
2-1	BATTERY REPLACEMENT	2-11
3-1	LPH 214/514 CONTROLS	3-8
4-1	LPH RECEIVE BLOCK DIAGRAM	4-7
5-1	REFERENCE MODULATION ADJUSTMENT	5-5
5-2	TRANSMITTER TROUBLESHOOTING FLOWCHART	5-6
5-3	SYNTHESIZER TROUBLESHOOTING FLOWCHART	5-8
5-4	LPH RECEIVER TROUBLESHOOTING FLOWCHART	5-10

KING
LPH 202/214/502/514
VHF FM COMM TRANSCEIVER

6-1	Typical Bill of Material.....	6-3
6-2	Model Versus Subassembly Chart	6-5
6-3	Assembly Flowcharts	6-7
6-4	Final Assembly	6-11
6-5	Portable Transceiver Interconnect	6-13
6-6	Receiver Frame Assembly, LPH 2 Channel	6-19
6-7	Receiver Frame Assembly, LPH 14 Channel	6-21
6-8	Front Cover Assembly	6-25
6-9	Keyboard/Display Assembly	6-29
6-10	Receiver Board Assembly	6-35
6-11	Receiver Board Schematic	6-37
6-12	5 Watt Transmitter Board Assembly	6-43
6-13	5 Watt Transmitter Board Schematic	6-45
6-14	2 Watt Transmitter Assembly	6-51
6-15	2 Watt Transmitter Schematic	6-53
6-16	System Board Assembly	6-57
6-17	System Board Schematic	6-59
6-18	Keyboard/Display Board Assembly	6-63
6-19	Keyboard/Display Board Schematic	6-65

TABLES

Table	Page
4-1 FREQUENCY INCREMENTS	4-6

KING
LPH 202/214/502/514
VHF FM COMM TRANSCEIVERS

SECTION I
GENERAL INFORMATION

1.1 INTRODUCTION

This manual contains information relative to the physical, mechanical, and electrical characteristics of the King Radio Corp LPH Series handheld VHF FM Communications Transceivers.

1.2 DESCRIPTION

The LPH series radios are a self contained VHF FM Transceiver covering the frequency range of 148MHz to 173.995MHz. Models are available in 2 watt 2 channel, 2 watt 14 channel, 5 watt 2 channel and 5 watt 14 channel versions. The 5 watt models have an external switch for Hi-Lo power output. CODE GUARD™, Scan, Transmitter time out timer, scan delay, and priority scan are built into the LPH 214/514. A variety of twist-off battery packs are also available.

1.3 TECHNICAL CHARACTERISTICS

LPH 202/214/502/514

FREQUENCY:	148-173.995MHz
POWER SUPPLY:	One rechargeable nickel-cadmium battery pack with temperature sensor or one Alkaline battery pack
CODE GUARD™ CTCSS & DCTSS:	Programmable
SQUELCH TAIL ELIMINATION:	Standard
PRIORITY CH, SCAN, TOT, SCAN DELAY	Programmable (LPH 214/514 Only)
CHANNELS:	
LPH 202	2
LPH 214	14
LPH 502	2
LPH 514	14
FREQUENCY SPREAD:	26 MHz with no degradation
OPERATING TEMPERATURE:	-30° to +60°c
PHYSICAL DIMENSIONS:	
Weight:	20 oz. (24 oz. with large battery pack)
Width:	2.55 in
Depth:	1.50 in
Height:	6.60 in (7.80 in with large battery)
ANTENNA TYPE:	Threaded Helical wound rubber flex (standard) BNC Helical wound rubber flex (optional)
CHANNEL SPACING:	30 Khz
FCC Identification number:	
5 Watt:	ASY90Q LT20001
2 Watt:	ASY90Q LT20002
MAX CURRENT DRAIN:	Transmit 2 watt: 575 mA Transmit 5 watt: 1.4 amps Receive: 165 mA Standby with battery save off: 45 mA Standby with battery save on: 15 mA

KING
LPH 202/214/502/514
VHF FM COMM TRANSCEIVERS

TRANSMITTER

RF OUTPUT POWER:

LPH 202	2 Watts
LPH 214	2 Watts
LPH 502	5 Watts (HI Power Mode) 2 Watt (LO Power Mode)*
LPH 514	5 Watts (HI Power Mode) 2 Watt (LO Power Mode)*

*Low power output is adjustable

MODULATION CHARACTERISTIC:	16F3, 15F2, and 16F9
SPURIOUS AND HARMONICS:	60 dB
MAXIMUM DEVIATION:	± 5 KHz
FM HUM AND NOISE:	43 dB
FREQUENCY STABILITY:	± 5 ppm
AUDIO DISTORTION:	5% maximum with 3KHz deviation
AUDIO RESPONSE:	+1 to -3dB from 6dB/Octave de-emphasis characteristic at 0.3 to 3 KHz
DUTY CYCLE:	Continuous

RECEIVER

SENSITIVITY:	
12dB SINAD:	0.25uV
NOISE SQUELCH:	0.18uV
SELECTIVITY:	70 dB
IMAGE AND SPURIOUS RESPONSES:	70dB
INTERMODULATION:	70dB
AUDIO OUTPUT:	500mW with 5% distortion maximum into an 8Ω load
AUDIO RESPONSE:	+1 to -3dB from 6dB/Octave de-emphasis characteristic at 0.3 to 3KHz

1.4 ACCESSORIES

The following units are available as optional accessories for the LPH hand held transceivers:

- A. LAA 0100 Standard Nicad Battery Pack, KPN 200-3224-00.
- B. LAA 0105 Large Nicad Battery Pack, KPN 200-3224-01.
- C. LAA 0106 Large Alkaline Battery, KPN 200-3237-00.
- D. LAA 0200 Speaker/Microphone, KPN 071-3012-04.
- E. LAA 0300 14 Hr. desktop trickle charger, KPN 062-0102-00.
- F. LAA 0310 1 Hr. desktop charger 121VAC, KPN 062-0103-00.
- G. LAA 0311 242VAC conversion kit for LAA 0310, KPN 050-2316-00.
- H. LAA 0340 14VDC Veh. trickle charger, KPN 062-0107-00.
- I. LAB 0356 14VDC 1 Hr veh. charger, with speaker and microphone.
- J. LAA 0810 Std port antenna 148-174MHz, KPN 071-1299-01.
- K. LAA 0811 BNC port antenna, KPN 071-1299-20.

KING
LPH 202/214/502/514
VHF FM COMM TRANSCEIVERS

- L. LAA 0812 BNC Conversion Kit, KPN 050-2185-00
- M. LAA 0700 Cloning cable and Programming Manual, KPN 200-3467-00
- N. LAA 0701 Programming Plug and Programming manual, KPN 200-3466-00
- O. LAA 0705 RS232 Interface and Manual, KPN 200-3236-00
- P. LAA 0600 Portable tool kit, includes the following: Spaner and ant wrench, Accy Cable, RF cable, Audio cable and Battery Eliminator, KPN 200-3465-00

1.5 LICENSE REQUIREMENTS

This equipment must be licensed by the Federal Communications Commission before it may be used. Your King Radio dealer can assist you in filing the appropriate application for the FCC and will program each radio with your authorized frequencies, signaling codes, etc.

1.6 SERVICE INFORMATION

If you have questions regarding service you may contact the factory at the address below:

King Radio Corporation
Mobile Communications Division
P.O. Box 3347
Lawrence, Kansas 66046-0347
(913) 842-0402

1.7 WARRANTY INFORMATION

KING RADIO CORPORATION's Mobile Communications Division ("Warrantor") warrants to the purchaser of new radio equipment of the warrantor's manufacture that such equipment shall be free from defects in material and workmanship for a period of one (1) year from the earlier of (a) installation of the equipment or (b) two months from the date of purchase of the equipment. Equipment and accessory items not manufactured by the Warrantor carry the standard warranty of the manufacturer thereof.

This warranty does not cover equipment which has been (a) damaged or not maintained as reasonable and necessary, (b) modified in any way, (c) improperly installed, (d) repaired by someone other than the warrantor or an authorized warranty repair station, or (e) used in a manner or purpose for which the equipment was not intended. This warranty shall not extend to incidental or consequential damages arising from operation of the equipment or from any claimed breach of this warranty.

To obtain warranty repair, the customer must return the equipment properly packaged, freight prepaid, to warrantor or any authorized warranty repair station. The equipment will be returned freight prepaid.

This warranty is the only warranty with respect to the equipment and is expressly in lieu of all other warranties, express or implied. Warrantor hereby DISCLAIMS ANY IMPLIED WARRANTY OR MERCHANTABILITY AND THE IMPLIED WARRANTY OF FITNESS FOR ANY PARTICULAR PURPOSE. No person, whether in the employ of the warrantor or not is authorized to make oral or other modifications, extensions, or additions to this warranty, unless approved in writing by an authorized officer of the warrantor at its home office.

The liability of the warrantor is expressly limited to the repair or replacement of the equipment as described herein. The warrantor shall not be liable to the purchaser and the purchaser, shall upon his tender of the purchase price for the equipment, agree that the warrantor shall not be liable, in any respect, for the equipment or damages caused thereby, except as prescribed herein, whether such liability is predicated upon negligence, tort, contract, or other products liability theory.

SECTION II INSTALLATION AND PROGRAMMING

2.1 GENERAL INFORMATION

This section contains suggestions and factors to consider before installing the LPH 202/214/502/514. Close adherence to these suggestions will assure optimum performance from the equipment.

2.2 UNPACKING AND INSPECTING EQUIPMENT

Exercise extreme care when unpacking the equipment. Make a visual inspection of the unit for evidence of damage incurred during shipment. If a claim for damage is to be made, save the shipping container to substantiate the claim. The claim should be promptly filed with the transportation company. It would be advisable to retain the container and packaging material after all equipment has been removed in the event that equipment storage or reshipment should become necessary.

2.3 PROGRAMMING

2.3.1 INTRODUCTION

There are two basic types of radios offered by King Mobile Communications. The first are units with an internal keyboard and a display. These will be referred to as the MASTER units. Any MASTER unit can be programmed using its internal keyboard and display. MASTER units are also capable of transferring their program to any other King Radio of that type. The second type of radio has no keyboard or display. These will be referred to as SLAVES. A SLAVE must be programmed by an external source.

There are three possible techniques for programming:

- A. A MASTER unit can be programmed using its internal keyboard and display.
- B. Any King Radio (MASTER or SLAVE) can be cloned from a master unit by attaching a cloning cable from the MASTER to the CLONE and pressing a download button.
- C. Any King Radio can be cloned from a computer via a special RS 232 interface.

2.3.2 REVIEWING THE PROGRAM IN A MASTER RADIO

A. To Enter the Programming Mode:

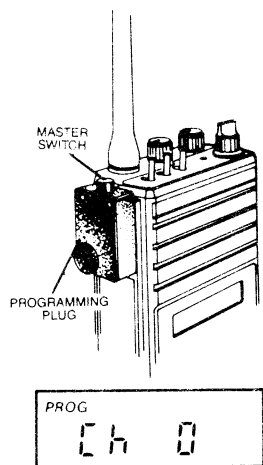

1. Make sure the battery pack is charged.
2. Insert the programming plug into the side connector of the radio. (Note: the cloning cable will serve as a substitute for the programming plug. However, the cloning cable has two plugs and the plug with the master switch must be plugged into the radio side connector.
3. Press and hold the master switch.
4. While holding the master switch, press the (FCN) key. After approximately three seconds the display will show PROG Ch 0. The radio is now in the programming mode.
5. Release the master switch and (FCN) key. The program is now ready to be reviewed.

KING
LPH 202/214/502/514
VHF FM TRANSCEIVERS

B. To Review General Radio Performance Variables (CH 0):

Channel 0 is the portion of the program that controls radio performance variables such as transmitter Time Out Timer, Scan Delay, Identification Number, Priority Scan Operation, etc.

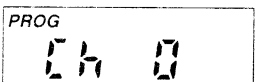
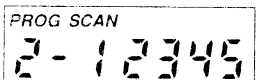
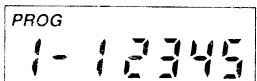
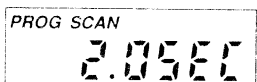
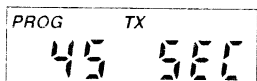
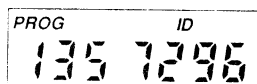
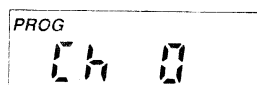

ENTRY POINT

1. After entering the program mode, the display will show PROG Ch 0.
2. Press the (FCN) key. The display will show an ID number (up to seven digits in length).
3. Press the (FCN) key. The display will show the Transmitter Time Out Timer length in seconds.
4. Press the (FCN) key. The display will show the Scan Delay Length in seconds.
5. Press the (FCN) key. The display will show five individual functions that can be enabled or disabled.
6. Press the (FCN) key. The display will show a second group of five functions.
7. Press the (FCN) key. The display will loop back to the Channel 0 entry point and show PROG Ch 0.

C. To Review Frequencies and CODE GUARDS™ for an Individual Channel:

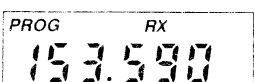
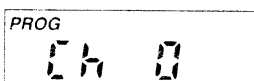

CARRIER SQUELCH

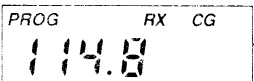

CODE GUARD™

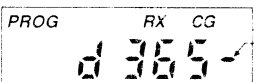

DIGITAL CODE GUARD™

INDICATES
INVERTED
CODE

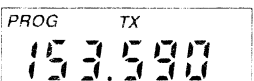

1. After entering the program mode, the display will show PROG Ch 0.
2. Press (CLR) then press the digit keys of the channel that needs to be reviewed. The display will show the channel to be reviewed.
3. Press the (FCN) key. The display will show the receive frequency in MHz.
4. Press the (FCN) key. The display will show the receive CODE GUARD™ or Digital CODE GUARD™ (the value 0.0 denotes carrier squelch). Digital CODE GUARD™ will be a three digit number preceded by a "d" in the display.
5. Press the (FCN) key. The display will show the transmit frequency in MHz.
6. Press the (FCN) key. The display will show the transmit CODE GUARD™ or digital CODE GUARD™. (Digital CODE GUARD™ illustrated.)

KING
LPH 202/214/502/514
VHF FM TRANSCEIVERS

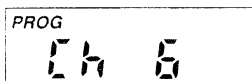
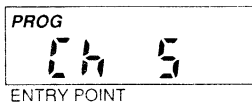
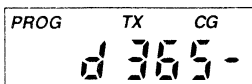

7. Press the (FCN) key. The display will loop back to the entry point and display the reviewed channel.
8. Press (CLR) then press the digit key of the next channel to be reviewed, or press (PRI) to increment the channel number one digit. The function key can then be used to review the frequencies and CODE GUARDS™ of this channel.
9. To leave the programming mode, power the unit down by rotating the volume knob counter clockwise to the off position. Remove the programming plug. Normal operation will occur on the next power up.

2.3.3 PROGRAMMING A MASTER RADIO THROUGH THE INTERNAL KEYBOARD AND DISPLAY

A. To Enter the Programming Mode:

1. Make sure that the battery pack is charged.
2. Insert the programming plug into the side connector of the radio. (Note: The cloning cable will serve as a substitute for the programming plug. The cloning cable has two plugs, the plug with the master switch must be plugged in to the radio side connector.)
3. Press and hold master switch.
4. While holding the master switch, press the (FCN) key for approximately three seconds. The display will show "PROG Ch 0". The radio is now in the programming mode.
5. Release the master switch and (FCN) key. The radio is now ready to be programmed.

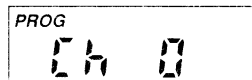

B. To Program General Radio Performance Variables (CH 0):

"Channel 0" is the portion of the program that controls radio performance variables such as Transmitter Time Out Timer, Scan Delay, Identification Number, Priority Scan Operation, etc.

C. To Set the ID Number

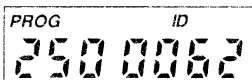
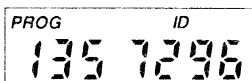

1. After entering the program mode, the display will show "PROG CH 0".
2. Press the (FCN) key.
3. The display will show up to a seven digit ID number. This seven digit number is intended as an electronic serial number for radio system management. An option must be added to the radio to allow this number to be transmitted.
 - 4a. If no change is needed for the ID number, press (FCN) to advance to the next section.
 - 4b. A new number can be entered by pressing (CLR) followed by any number up to seven digits. The digits will appear at the right of the screen and move to the left as more digits are entered. Press (ENT) to store the new ID number and the program will automatically advance to the next section.
 - 4c. If desired, the existing ID number can be incremented one digit by pressing (PRI). Then press (ENT) to store the new ID number and automatically advance to the next section.

D. To Set the Transmitter Time Out Timer

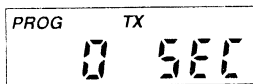

After the ID number is set, the upper display will show "PROG TX." This is the duration of the transmitter Time Out Timer. "0 SEC" means that the Time Out Timer is inhibited.

1. If no change is needed, press (FCN) to advance to the next section.
2. The Time Out Timer length can be changed by pressing the (PRI) or (CLR) key. Each press of the (PRI) key will increase the length by 15 seconds. Up to 225 seconds (3 minutes, 45 seconds). Another press after 225 seconds resets the value to 0. Pressing the (CLR) key will automatically reset the value to 0. Press (ENT) to store the chosen value and automatically advance the program to the next section.

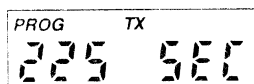

E. To Set the Scan Delay Time

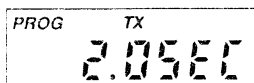

After the Time Out Timer is set the upper display will show "PROG SCAN." This is the duration of the scan delay time in seconds.

1. If no change is needed, press (FCN) to advance to the next section.
2. The scan delay length can be changed by pressing the (PRI) or (CLR) key. Each press of the (PRI) key will increase the scan delay time by .5 seconds up to 7.5 seconds. Another press after 7.5 seconds resets to 0. Pressing the (CLR) key will automatically reset the value to 0. Press (ENT) to store the chosen value and automatically advance the program to the next section.

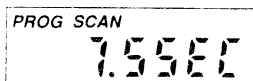

Note: It is not recommended to leave the scan delay time at "0" seconds.

F. Miscellaneous Channel O Programming - GROUP 1

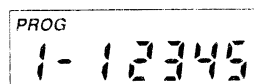

After the scan delay time is set the display will show "PROG 1-12345." This is a group of five individual functions that can be enabled or disabled.

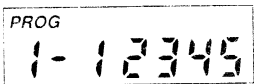

When a function is enabled, the corresponding number in the display will flash. When the function is disabled the number is steady. If you wish to change the function from enable to disable or vice versa, press the number key corresponding to that function.

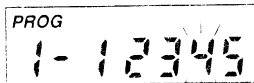

Example: If function #4 (priority key lockout) is disabled, the "4" in the display will not be flashing. If the (4) key is pressed, the "4" in the display will flash signifying that priority key lockout is enabled. A subsequent press of the (4) key will return priority key lockout to a disabled status.

G. GROUP ONE Functions

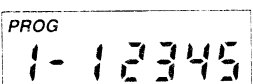

BATTERY SAVER ON

1. Battery Saver Inhibit - When enabled (flashing), this turns off the battery saver. The battery saver should be turned off only to get proper voltage readings during service or in systems requiring extremely fast squelch attack time. Note: King Radio current drain and battery life specifications are based on performance with the battery saver on.

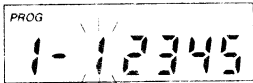

BATTERY SAVER OFF

KING
LPH 202/214/502/514
VHF FM TRANSCEIVERS

2. & 3. Functions 2 and 3 are used to define priority scan operation. There are three types of priority scan available. Their operational characteristics are thoroughly discussed in Section 3.2.5 E of this manual. In summary:

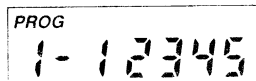

PRIORITY MODE A

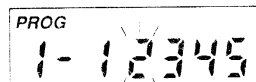

PRIORITY MODE B



PRIORITY MODE C

Priority Mode A - The priority channel follows the position of the channel select knob.

Priority Mode B - The priority channel is fixed. You will transmit on the channel selected by the channel select knob channel.

Priority Mode C - The priority channel is fixed. When the PRI toggle switch is on, you will transmit on the priority channel regardless of the channel select knob setting.

To set function 2 and 3 for priority mode A, B, or C, use the following chart:

	FUNCTION 2	FUNCTION 3
PRIORITY MODE A	DISABLE (STEADY)	DISABLE (STEADY)
PRIORITY MODE B	ENABLE (FLASHING)	DISABLE (STEADY)
PRIORITY MODE C	ENABLE (FLASHING)	ENABLE (FLASHING)

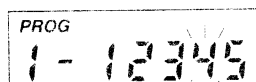

PRIORITY CHANNEL NOT CHANGEABLE

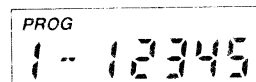

PRIORITY CHANNEL CHANGEABLE

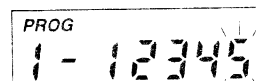

SCAN LIST NOT CHANGEABLE

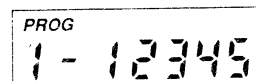

SCAN LIST CHANGEABLE

4. (PRI) Key Lockout- When enabled (flashing) the (PRI) key will be locked out in the operating mode. The user will not be able to change the designation of the Priority Channel. When disabled (steady) the user will be able to change the channel that is designated as Priority Channel.

See Section 3.2.5 F for instructions on changing the Priority channel. See Section 3.2.5 G for instructions on locking out the Priority channel.

5. Scan List Lockout - When enabled (flashing), the user will not be able to change the channels in the scan list. When disabled (steady), the user can enter or delete channels from the scan list.

See Section 3.2.5 C for instructions on changing the scan list.

See Section 3.2.5 D for instructions on locking out the scan list.

Once each function 1-5 is set as desired, press (ENT) to store them into memory and automatically advance the program to the next section.

If no changes have been entered, press (FCN) to advance to the next section.

H. Miscellaneous Channel 0 Programming - GROUP 2

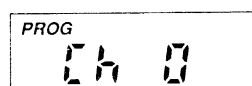
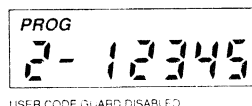
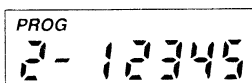

After group 1 functions are set the display will show PROG 2-12345 for Group 2 functions. As with Group 1 functions, the enabled function number will flash. the disabled functions remain steady.

1. User Code Guard Selection

When enabled (flashing) the user will be able to press the keyboard to independently select the code guard values that are programmed into channels 1 thru 9 while operating on any channel 1 thru 14. When disabled the user will be unable to use the keyboard for code guard selection. See Section 3.2.5. H for operation procedures of this function.

NOTE: This feature available on select models only. Features 2 thru 5 are reserved for future options and should remain disabled at this time.

Once Group 2 functions are set, press (ENT) to store the functions into memory. The display will revert back to the CH0 entry point.

I. To Review Channel 0 Values

Repeated pressing of the (FCN) key will display each value in Channel 0, then loop back to the "Ch 0" entry point.

J. To Enter Frequencies and CODE GUARD™ Values for Channel 1:

Once Channel 0 programming is complete, the display will show "PROG Ch 0". Any channel number can now be pressed to allow access to the frequency and CODE GUARD™ values for that channel.

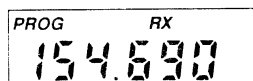
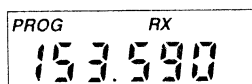
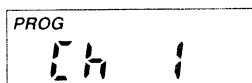

1. Press (1) and the display will show "PROG CH 1". This is the entry point for channel 1 values.

2. Press (FCN) and the upper part of the display will show "PROG RX". This is the receive frequency for channel 1 (in MHz).

3. If the displayed frequency is correct, press (FCN) to advance to the next value.

If a new frequency is desired, press (CLR) followed by the digits of the desired frequency from left to right. Then press (ENT) to store this frequency and automatically advance to the next value.

Only frequencies from 148 to 173.995 Mhz will be operable.

See Section 4.3.5 for frequency increments.

KING
LPH 202/214/502/514
VHF FM TRANSCEIVERS



- After the receive frequency is set the upper part of the display will show "PROG RX CG". This is the CODE GUARD™ value for Channel 1 receive. Note: 0.0 indicates carrier squelch operation.

If the displayed value is correct, press (FCN) to advance to the next value.

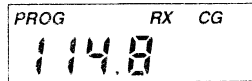

If a new value is desired, press the (CLR) key to reset the display to 0.0 (CODE GUARD™ inhibited). Tone CODE GUARD™ is entered directly, using the digit keys (0 thru 9). See Section 2.3.8. Digital CODE GUARD™ is entered by first pressing (CLR), then the (#) key, causing the letter "d" to appear, followed by the proper three digit code (0 thru 7 keys only. 8 & 9 respond as a 7.) See Section 2.3.9. Pressing the (PRI) key after the three digit code has been entered allows the digital code to be inverted. When the displayed value is correct, press (ENT) to store the CODE GUARD™ and automatically advance to the next value.



- After the receive CODE GUARD™ is set the upper part of the display will show "PROG TX." This is the transmitter frequency for Channel 1. If it is correct, press (FCN) to advance to the next value.

If you wish to change it, press (CLR) followed by the frequency in (MHz) then (ENT) to store the new frequency and automatically advance to the next value.

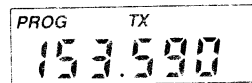

Only frequencies from 148 to 173.995Mhz will be operable. See Section 4.3.5 for frequency increments.

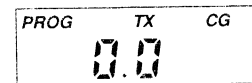

- After the transmit frequency is set the upper part of the display will show "PROG TX CG>" This is the CODE GUARD™ value for Channel 1 transmit (0.0 indicates carrier squelch). If this value is correct press (FCN) to advance to the next value.

If a new value is desired, follow the procedure for receive CODE GUARD™ as described in step 4.

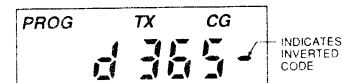
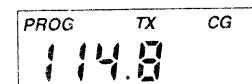

- After the transmit CODE GUARD™ is set, the display will loop back to the Channel 1 entry point. If you wish to review the frequencies and CODE GUARD™ values in Channel 1, subsequent pressing of the (FCN) key will show each value and then loop back to the Channel 1 entry point.

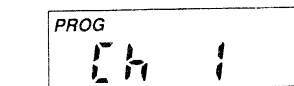

KING
LPH 202/214/502/514
VHF FM TRANSCEIVERS

J. To Enter Frequencies and CODE GUARD™ Values for any Channel

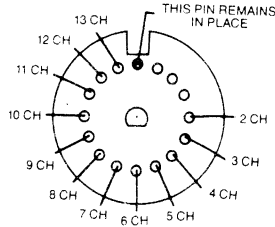
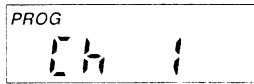

1. After Channel 1 information is set, the display will loop back to show "PROG CH 1". Press (CLR) followed by the digits of any other channel number to gain access to the frequencies and CODE GUARDS™ values for that channel. Each channel is then programmed using the same technique as previously outlined for Channel 1.

2. After the frequencies and CODE GUARD™ values are entered for each channel, the channel select knob can be modified to limit its travel. Remove the channel select knob from the radio. There are two .025" square pins. The pin centered at the channel number opening on the skirt should remain in place at all times. The second pin can be set to limit the travel from two to 14 channels as needed. Press the pin in to the appropriate hole as shown. If all 14 channels are programmed, the second pin should be removed.

K. To Leave the Programming Mode:

1. Rotate the on/off/volume knob on top of the radio counter clockwise to the off position.
2. Remove the programming plug.
3. Normal radio operation will occur on the next power up.

2.3.4 CLONING A RADIO FROM A MASTER

Any MASTER radio (unit with internal keyboard and display) is capable of transferring its program to another MASTER or SLAVE (unit without keyboard). Note: Both units must be of the same frequency band. The radio receiving the program will be referred to as the CLONE.

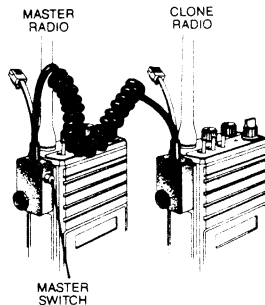

1. Make sure that both battery packs are charged.
2. Attach the MASTER switch end of the cloning cable to the side connector of the MASTER radio. (Note: one plug of the cloning cable has a push button MASTER switch. This plug must be attached to the MASTER radio.)
3. Power up the MASTER radio by rotating the off/volume knob clockwise past the detent.
4. To put the MASTER radio in the programming mode, press and hold the MASTER switch. Then press the (FCN) key until the display shows "PROG CH 0".
5. Review the values in the program. Any changes required must be made at this time.
6. Connect the other plug of the cable to the side connector of the radio to be cloned.
7. Power up the clone.
8. Press the (*) key on the MASTER radio keyboard. The display will flash "PROG" signifying that the radio is ready to download.

KING
LPH 202/214/502/514
VHF FM TRANSCEIVERS

9. Press (FCN) key. The program in the MASTER will be downloaded to the clone. The clone will send back the program to the MASTER to verify successful cloning.
10. If the download was successful, the MASTER will resume flashing "PROG". Power down the clone. Disconnect the cable. Normal radio operation will occur on the next power up.
11. If the download was not successful the MASTER will display "FAIL" and multiple beeps will follow. Failure of downloading can be due to:

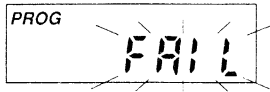

- A. Incorrect radio types (VHF tries to program UHF or vice versa).
- B. Improper connection.
- C. Failure to power up clone.
- D. Clone set in programming mode.

Note: To stop fail mode, press (CLR), power down the radios, and try again starting at step 1.

2.3.5 SPECIAL CLONING INSTRUCTIONS

It is possible to change "Channel 0" values on the MASTER radio, hold them in a temporary memory, and download them to the clone without actually entering them into the permanent memory of the MASTER. This is convenient for sequential identification numbers used to identify a series of portables in a radio system. Assuming that the frequencies, CODE GUARDS™ values, and other "Ch 0" values are common for all radios in the system, but that the radio identification number should be unique to each radio, the following method would be used to clone additional radios for the system:



1. Program the MASTER with all frequencies, CODE GUARD™ values and Channel "0" values that will be common to all radios.
2. Advance the display to show the MASTER's ID number (for example #100).
3. Press (CLR); press (1) (2) (5). #125 is now in temporary memory.
4. Press (*), connect the cable to clone and download by pressing (FCN). ID #125 is now stored in permanent memory of the clone.
5. After download press (CLR). Disconnect the clone. The MASTER radio display will show that #125 is still being held in the temporary memory of the MASTER.
6. Press (PRI). This will increment the ID number one digit to #126. (Note: any new number can be entered at this point by pressing (CLR) and using the digit keys to enter the new number.)
7. Press (*). Connect cable to the second clone and download by pressing (FCN).
8. Any number of radios can be coded with different or sequential ID numbers using this technique. The ID number in the permanent memory of the MASTER will remain unchanged as #100.



KING
LPH 202/214/502/514
VHF FM TRANSCEIVERS

2.3.6 SCAN LIST AND PRIORITY CHANNEL CLONING

When a MASTER downloads to a clone, the scan list and priority channel designations are also transferred to the clone. This includes priority mode and any lockout functions.

If electing to program a clone with a set priority mode, priority channel and scan list along with the respective lockout functions (if desired), the MASTER radio must first be programmed with these parameters. Hence whatever is programmed in the master will be downloaded to the clone radio. See the appropriate operating procedures in section 3.2 for selecting the scan list, priority channel and lockout functions. See Section 2.3.3 G for priority mode selection.

2.3.7 CLONING VIA RS 232 INTERFACE

Programming from a computer via the RS 232 interface is covered in a separate programming manual. Contact your King sales representative and order model LAA 0705.

2.3.8 SELECTING A TONE CODE GUARD™

The tone CODE GUARD™ system may be set for any frequency in the range of 67 to 250.3 Hz. However, since most systems adhere to the Electronic Industry Association (EIA) standards, tones should be selected from the following EIA list. In order to insure optimum performance tone selection for use on the same radio frequency (RF) channel or adjacent channels in the same coverage area should be made from one of the Groups A, B, or C to the maximum degree possible. King Radio guarantees optimum receiver performance only if tone frequencies below 220 Hz are chosen.

<u>GROUP A</u>		<u>Group B</u>		<u>Group C</u>
67.0	*151.4	71.9	146.2	74.4
77.0	162.2	82.5	156.7	79.7
88.5	173.8	94.8	167.9	85.4
*100.0	186.2	103.5	*179.9	91.5
107.2	203.5	100.9	192.8	
114.8	218.1	*118.8	210.7	
123.0	233.6	127.3	225.7	
131.8	250.3	136.5	241.8	
141.3				

* 50/60 Hz power distribution systems could cause flashing.

The assignments in a given area shall be made from one of the Groups A, B, or C to the maximum degree possible.

2.3.9 SELECTING A DIGITAL CODE GUARD™

Codes for the Digital CODE GUARD™ system may be chosen from the following list. Since there are no EIA standards for the performance or compatibility of Digital CODE GUARD™ systems it is recommended that an operational test be made on the intended system before wholesale assignments are made. In some cases either or both the transmit and receive codes will require an inverted code to operate with existing systems. This can be done during the code programming of the system. Usually systems using direct unit to unit transmission (systems without mobile relays, repeaters, remote control, etc) may use codes from the table. Systems with relays etc. may use code variations for system control and operational efficiency. The system operator or engineer should be consulted regarding the operational requirement on such systems.

023	065	131	172	251	331	412	466	612	703
025	071	132	174	261	343	413	503	624	712
026	072	134	205	263	346	423	506	627	723
031	073	143	223	265	351	431	516	631	731
032	074	152	226	271	364	432	532	632	732
043	114	155	243	306	365	445	546	654	734
047	115	156	244	311	371	464	565	662	743
051	116	162	245	315	411	465	606	664	754
054	125	165							

2.3.10 BATTERY REPLACEMENT

- A. To remove the battery, turn the radio off. Press up the metal tab on the side of the case while twisting the battery pack approximately 30° and remove it from the radio.
- B. To reinstall the battery, locate the center hub on the radio base and place it in the recesses of the battery pack. Position the pack at the 30° offset, seating two metal studs in their recess. Apply upward pressure to the pack while twisting the pack to its original position. The metal tab will click, locking the pack in position.
- C. King battery packs are available in a variety of sizes and types for special applications. Rechargeable packs can be charged separately or while attached to a radio.
- D. Periodically check the contacts on battery pack for dirt that may prevent a good electrical contact with the charging base.
- E. Do not dispose of a battery pack in fire. An explosion may occur.

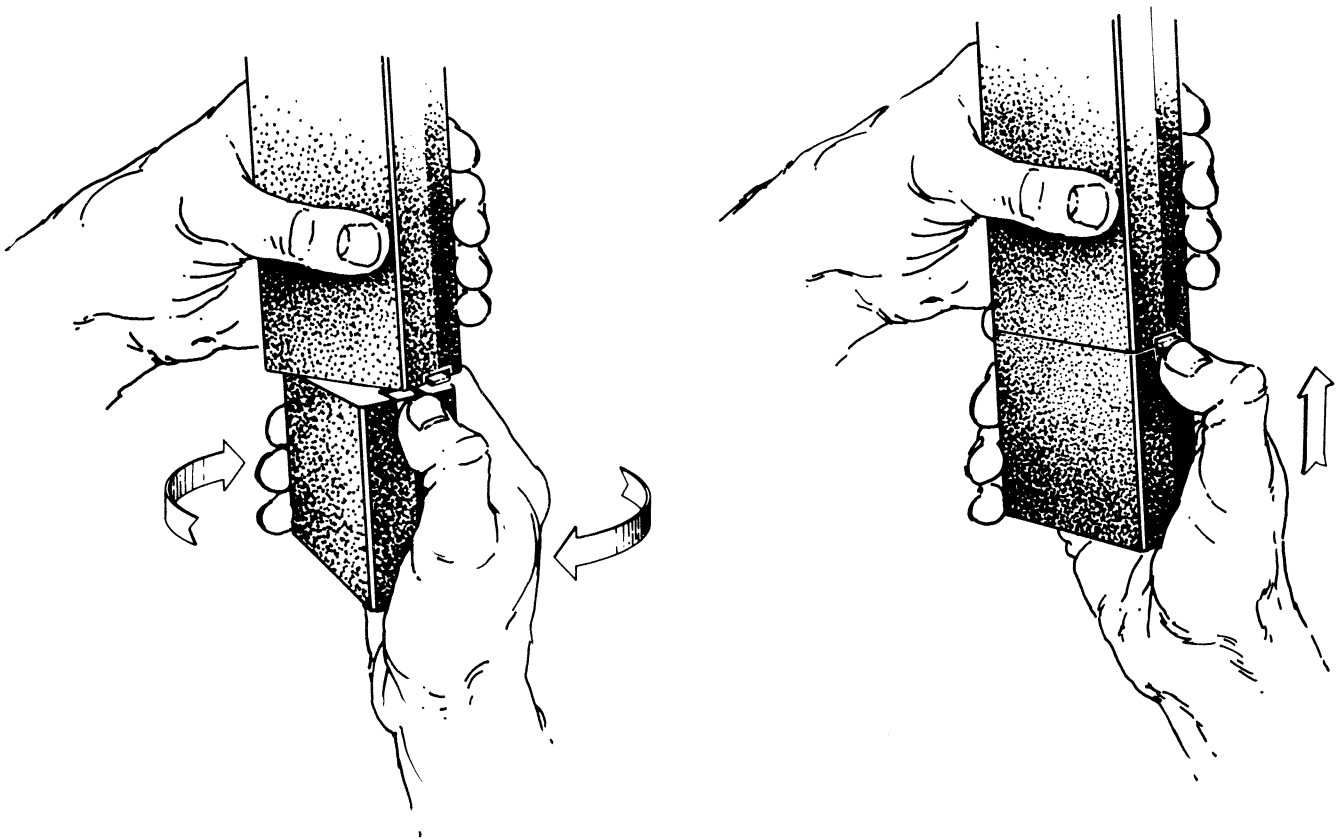

FIGURE 2-1 BATTERY REPLACEMENT

SECTION III OPERATION

3.1 INTRODUCTION

This section contains a basic operation procedure for the LPH hand held VHF FM Transceivers. Information on programming and installation is contained in section 2 of this manual.

WARNING

DO NOT OPERATE THIS UNIT IN CLOSE PROXIMITY TO BLASTING CAPS. DO NOT OPERATE THIS RADIO IN AN EXPLOSIVE ATMOSPHERE (PETROLEUM FUELS, SOLVENTS, DUST, ETC).

3.2 OPERATION

3.2.1 BASIC OPERATION

A. Receive (Listen)

Turn the power on by rotating the VOL (volume) knob clockwise past the OFF detent. Select the appropriate channel using the Channel Select knob (14 channel) or toggle switch (2 channel). Rotate the SQ (squench) knob clockwise until a rushing noise is heard. Set the volume to a comfortable level, then rotate the SQ knob counter-clockwise until the noise stops. This is called the squench threshold setting. Further rotation counter-clockwise tightens the squench setting, making it necessary for stronger signals to open the squench and allow a message to be heard.

B. Transmit (Talk)

Press and hold the side PTT (push to talk) switch. The transmit LED will glow red when the transmitter is on. Talk in a normal voice with the speaker one to two inches from your lips. Make each transmission as brief as possible. Release the PTT switch to end the transmission.

If the transmit LED does not glow when you press the PTT switch, the battery pack may need to be charged. If the transmit LED does not glow and a tone is heard, you are on a receive only channel. Switch the channel selector to an authorized transmit channel. If the length of your message exceeds the preset time out timer setting, the transmitter will automatically shut off and a tone will be heard. If you wish to continue the transmission, release the PTT, then press, hold, and continue talking.

3.2.2 CODE GUARD™ OPERATION

CODE GUARD™ allows one radio or group of radios to be selectively called within a system. If the radio has been programmed with CODE GUARD™, use the following receive and transmit instructions.

A. Receive (Listen)

Turn the power on by rotating the VOL (volume) knob clockwise past the OFF detent. Rotate the SQ (squench) knob clockwise until a rushing noise is heard. Set the volume to a comfortable level then rotate the SQ knob completely counter-clockwise, past the detent for CODE GUARD™ operation. A message will be heard only when the programmed CODE GUARD™ is being transmitted.

B. Transmit (Talk)

Before transmitting on CODE GUARD™ channels, monitor the channel by turning the SQ knob clockwise, off the detent. If the channel is not busy, press and hold the side PTT (push to talk) switch. The Transmit LED will glow RED when the transmitter is on. Talk in a normal voice with the speaker one to two inches away from your lips. Make each transmission as brief as possible. Release the PTT switch to end transmission. Reset the SQ knob to the CODE GUARD™ position.

KING
LPH 202/214/502/514
VHF FM TRANSCEIVERS

If the Transmit LED does not glow when you press the PTT switch, the battery pack may need to be charged. If the Transmit LED does not glow and a tone is heard, you are on a receive only channel. Switch the channel selector to an authorized transmit channel. If the length of your message exceeds the preset time out timer setting, the transmitter will automatically shut off and a tone will be heard. If you wish to continue this transmission, release the PTT, then press and hold.

3.2.3 TRANSMIT POWER (LPH 502/514 models only)

Placing the HI/LO toggle switch in the HI position enables full transmitter power. The LO position reduces power to about one watt thereby reducing current drain and increasing battery life.

3.2.4 BUILT IN FEATURES

Select King radios are based on a microprocessor core that allows certain features and operational characteristics to be built in to the radio. You should define the best operational settings for your customer's system and program them in to the radio.

Additional transmit and receive frequencies, up to 14, can be added. If you wish to monitor other local radio systems that fall anywhere in the band, a frequency with or without CODE GUARD™ can be added to the program.

The radio comes equipped with a time out timer. This is used to limit the duration of calls and to guard against accidental PTT locking on the transmitter and tying up the radio system. The duration of the time out timer can be changed from 0 - 3.75 minutes as required.

A SCAN delay is included to allow a response to a transmission to be received before the scanner moves on to search for new activity. If you find that the scanner is restarting before message replies are heard, increase the scan delay time. (0 - 7.5 seconds)

There are three different priority modes available. These are discussed in the priority section of this manual. System needs and suggestions should be discussed with the customer.

3.2.5 OPERATIONAL FEATURES AVAILABLE ON SELECT MODELS

A. Scan Operation

When in the scan mode, the radio receiver samples channels in a predetermined list (scan list) looking for activity. If an active channel is found, the scanning action stops and the message on that channel is heard. Once the message stops, the receiver will wait for a response before scanning resumes. This waiting period is called the "scan delay time". It can be preset (from 0 seconds to 7.5 seconds). The scan list has also been preset. On some radios you will be able to add or delete channels from the scan list. The channel, that the Channel Selector Knob is set to, is always included in the scan list.

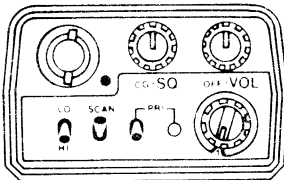

FIG A

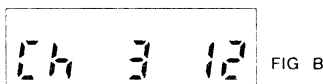

FIG B

To begin scanning, place the SCAN toggle switch in the SCAN position. Scan operation occurs only while the radio is receiving. After SCAN is enabled, two flashing bars on the right side of the display (Figure A) indicate that the radio is scanning the channels in the Scan List.

When a signal is detected, scanning stops and the signal being received is heard, with active channel shown on the right side of the LCD display. (Figure B) The radio receiver stays tuned to that channel until activity ceases and resumes scanning after the "scan delay" time.

If you wish to transmit on the last active scan channel (right side of display), turn the Channel Select Knob on top of the radio to match that channel. (Figure C) Turn OFF the SCAN toggle switch for normal talk-listen operation.

KING
LPH 202/214/502/514
VHF FM TRANSCEIVERS

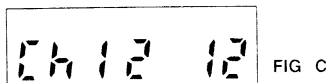

When the PTT is pressed while in the scan mode, the radio transmits on the "transmit" (left side of display) channel. Upon release of PTT, the radio receiver will hold on that channel. If no activity occurs during the "scan delay" time, the radio resumes scanning.

B. Scanning CODE GUARD™ Channels

To scan for channels with programmed CODE GUARD™, rotate the SQ knob completely counter-clockwise, past the detent. When a signal is detected, scanning stops and the CODE GUARD™ for that channel is checked. If the proper CODE GUARD™ is present, the radio receives on that channel until CODE GUARD™ ceases. If the proper CODE GUARD™ is not present the radio receiver will resume scanning immediately.

C. Changing the Scan List

The radio can be programmed with a permanent or changeable scan list. If the scan list can be changed, use the following steps to enter or clear channels.

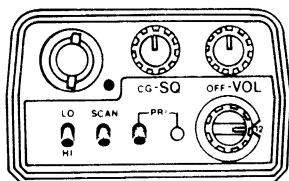

To avoid confusion, turn OFF the PRI and SCAN toggle switches on the top of the radio.



Turn the Channel Select Knob to the channel to be entered or cleared.

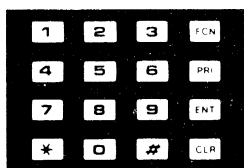

To ENTER a channel into the scan list, press the [ENT] key on the keyboard. A short beep will be heard. "SCAN" will be shown in the LCD display.(Figure D)

To CLEAR a channel from the scan list, press the [CLR] key. A short beep will be heard, and the "SCAN" in the display will disappear.

D. Permanent Scan List

To make the scan list permanent enter the program mode CH0. Press the FCN key until Group 1 functions appear (1-12345). Press the digit 5 so it begins to flash, then press (ENT). The scan list is now permanent in the normal operation mode and cannot be changed until the scan lockout function has been reversed.

E. Priority Operation

Priority operation consists of receiving on any channel while still monitoring for a message on the priority channel. Priority can also be used in combination with Scan operation.

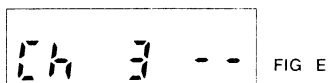

When the PRI (priority) toggle switch is turned ON, the channel designated "priority" is sampled 4 times a second, regardless of activity on any other channel. Two flashing bars on the right hand side of the display indicate that the radio is sampling the priority channel. (Figure E) If a signal is received on the priority channel, the radio receiver will lock on to this channel for the duration of the transmission.

When the SCAN toggle switch is ON and the PRI toggle switch is OFF, normal scanning will occur but priority channel will not be sampled. If both scan and priority toggles are off, the radio will function as in basic operation.

KING
LPH 202/214/502/514
VHF FM TRANSCEIVERS

There are three priority modes:

Priority Mode A - The priority channel is tied to the Channel Select Knob. When the selector is set on channel 5, this is the priority channel. If the selector is switched to channel 8, this becomes the priority channel. You will transmit on the frequency chosen by the Channel Select Knob.

Priority Mode B - The priority channel is fixed. You will transmit on the frequency chosen by the Channel Select Knob.

Priority Mode C - The priority channel is fixed. When the PRI toggle switch is ON, you will transmit on the priority channel regardless of the Channel Select Knob setting.

If you do not know which priority mode is preset for the radio, the following steps will identify it.

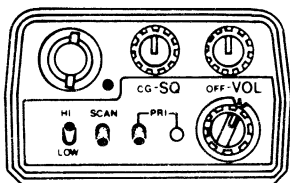

1. Set the PRI and SCAN toggle switches to OFF.
2. Rotate the Channel Select Knob, stopping at each detent to view the LCD Display.
3. If a "PR" symbol (in the upper left of the LCD Display) does not appear for any channel, you have priority Mode A. (Figure F)
4. If "PR" is displayed, rotate the Channel Select Knob to a different channel, then turn the PRI toggle ON.

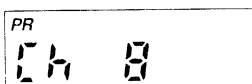

FIG F

If the LCD display doesn't show "PR", you have priority Mode B.

If the LCD Display changes and "PR" appears, you have priority Mode C.

Priority Mode A Details:

In this mode, the priority channel is tied to the Channel Select Knob. When the SCAN and PRI (priority) Toggle Switches are ON. Scanning will occur until an active scan channel is found. The radio will receive the active channel (Figure G) while continuing to sample the priority channel 4 times per second. If during this sampling the priority channel becomes active, the priority LED will light. The radio receiver will go to the priority channel and hold for the duration of the transmission. (Figure H) The active channel (scan or priority) will be shown on the right hand side of the display. If you wish to reply to a message on the priority channel, press the PTT and you will transmit on the priority channel. Once activity ceases on the priority channel, the radio returns to scan operation.

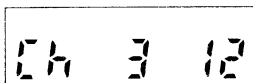

FIG G

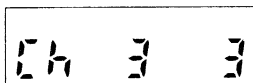
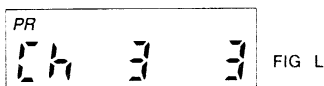
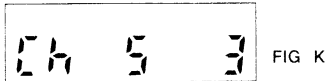
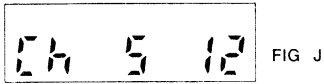

FIG H

KING
LPH 202/214/502/514
VHF FM TRANSCEIVERS

Priority Mode B Details:

This mode fixes one channel in the radio as the priority channel. With the SCAN toggle switch OFF and PRI (priority) toggle switch ON, the radio can receive on the Knob Selected Channel while still sampling the priority channel. If the priority channel becomes active, the Priority LED goes on and the radio holds on the priority channel for the duration of the transmission. If you wish to reply to a message on the priority channel, you must rotate the Channel Select Knob to the priority channel, then transmit.



With both SCAN and PRI toggle switches ON, normal scanning operation will occur until the scanner locks on to an active channel. (Figure J) The priority channel will continue to be sampled 4 times per second while the radio is listening to this active channel. If activity occurs on the priority channel, the radio will override the active scan channel, go to the priority channel, and hold for the duration of the transmission. (Figure K) If you wish to reply to a message on the priority channel, you must rotate the channel selector to the priority channel, then transmit. (Figure L) Once activity has ceased on the priority channel, the radio returns to scan operation.

Priority Mode C Details:

With the PRI toggle switch ON and SCAN switch OFF, radio operation is exactly the same as in Mode B. The fixed priority channel is sampled 4 times a second. If activity occurs on the priority channel, the radio will go to the priority channel and hold for the duration of the transmission. If you wish to reply to a message heard on the priority channel, press the push to talk and the radio will automatically transmit on the priority channel regardless of the setting of the Channel Select Knob. In Priority Mode "C" the radio will always transmit on the priority channel if the PRI toggle switch is ON. The priority LED will come on as a reminder that you are transmitting on the priority channel. Once activity has ceased on the priority channel, the radio will return to the Channel Select Knob receive channel.

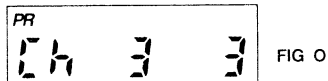
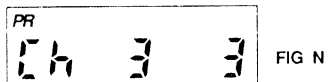
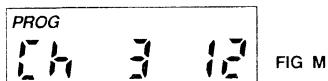

With both SCAN and PRI toggle switches ON, the radio will scan until it locks on to an active channel. (Figure M) The priority channel will continue to be sampled 4 times a second while the radio is listening to this active channel. If activity occurs on the priority channel, the radio will override the active scan channel, go to the priority channel and hold for the duration of the transmission. (Figure N) If you wish to reply to a message on the priority channel, press the PTT and the radio will automatically transmit on the priority channel regardless of the setting of the Channel Select Knob. In priority Mode "C" the radio will always transmit on the priority channel if the PRI toggle switch is on. (Figure O) The priority LED will come on to remind you that you are transmitting on the priority channel. Once activity ceases on the priority channel, the radio returns to scan operation.

KING
LPH 202/214/502/514
VHF FM TRANSCEIVERS

F. To Change the Priority Channel

The priority channel used in Priority Mode B and C may be permanently set or may be changeable. If the radio has changeable priority, use the following steps to make this change. Note: Only one channel can be designated as the priority channel.

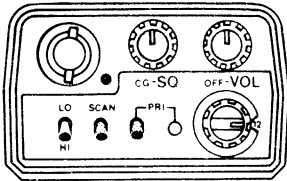

1. To avoid possible confusion, turn OFF the PRI and SCAN toggle switches on the top of the radio.
2. Turn the Channel Select Knob to the channel that you wish to enter as the new priority channel.

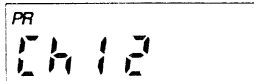
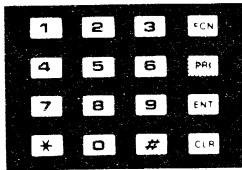

FIG P

A press of the [PRI] key causes a short beep, with letters "PR" displayed, indicating that the displayed channel is now the priority channel. (Figure P)



A channel can be both a priority and a scanned channel. Due to multiple sampling of the same channel, maximum performance occurs when the priority channel is not also a scan channel.

G. Setting Priority channel lockout

1. To lockout a priority channel setting the radio must first be programmed for priority mode B or C.
2. With the radio in normal operation mode set the channel select knob to the desired priority channel.
3. Press the (PRI) key on the keyboard. PR should appear on the display.
4. Enter the programming mode. While in CH 0 press the (FCN) key until Group 1 functions appear (1-12345).
5. Press the digit 4 on the keyboard. The 4 in the display should now be flashing.
6. Press ENT. Return the radio to normal operation mode by turning the radio off then back on again. The channel selected as priority channel should show PR on the upper portion of the display.
7. To verify priority channel lockout set the channel select knob to a different channel and press the (PRI) key. The PR symbol should not appear in the display.

H. User Code Guard™ (optional on selected models only)

The user Code Guard™ feature allows the user to select any of the Code Guard™ values that are programmed in channels 1 thru 9 while operating on any channel 1 thru 14. This feature only operates when a system uses one frequency with more than one Code Guard™ value and is operative in both receive and transmit modes.

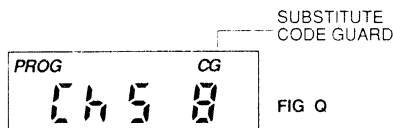

FIG Q

To select a Code Guard™ other than what is used by the channel setting of the channel select knob just press the digit on the keyboard of the channel (1 thru 9) you wish to use. The Code Guard™ selected will appear in the display as shown in Figure Q.

Pressing the digit 0 clears the selected Code Guard™ and normal channel operation will resume.

KING
LPH 202/214/502/514
VHF FM TRANSCEIVERS

NOTE: During scan or priority scan mode the display will not show the selected CG but will instead revert to the normal scan-priority display.

NOTE: Once a Code Guard TM value is selected by the keyboard it will not change even if the power is interrupted or if the channel selector is changed.

I. Programming Errors (Radios with keyboard microprocessors, KPN 122-0058-01)

If the channel selector switch is set to a channel containing an invalid receive frequency there will be no display indications after power up. If this should occur, rotate the channel select switch to a channel with a valid receive frequency. The display should then come on and normal radio operation will resume.

Another indication of an invalid frequency programmed into a channel is when the channel select switch is rotated and the channel shown in the display does not change.

*NOTE: Invalid frequencies include all frequencies less than 148.00MHz (including 0.0MHZ) and all frequencies above 173.995MHz.

Courtesy of :
Simpson260.com

KING
LPH 202/214/502/514
VHF FM TRANSCEIVERS

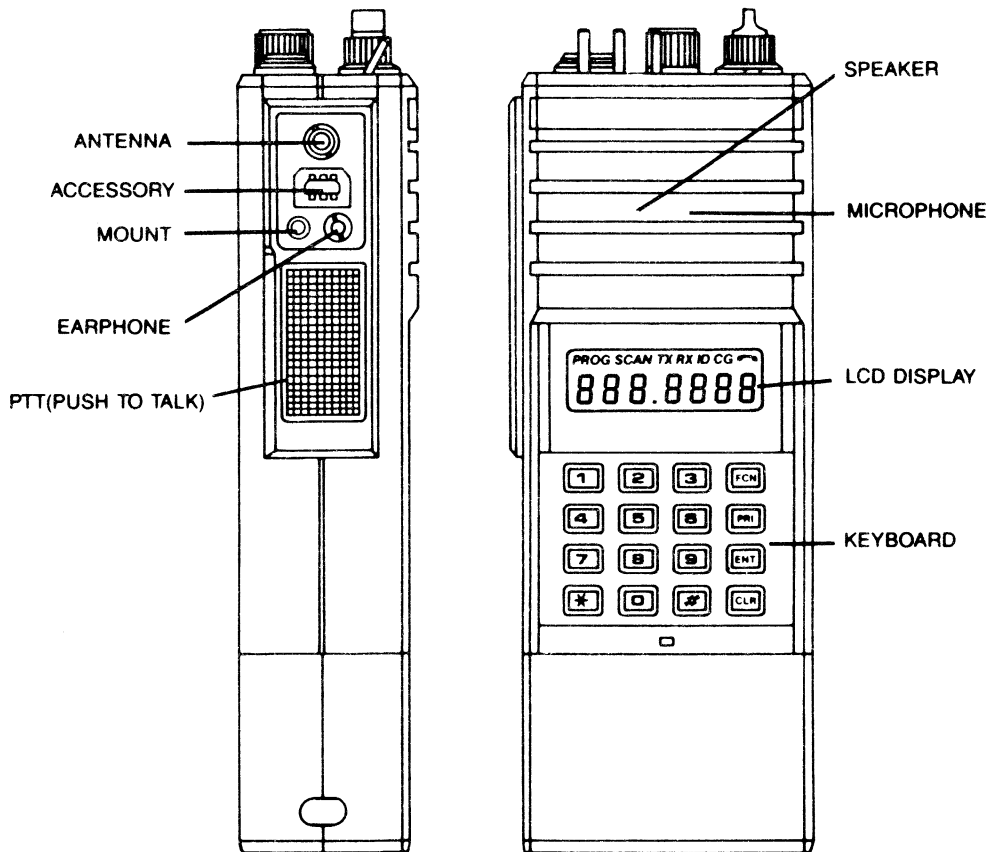
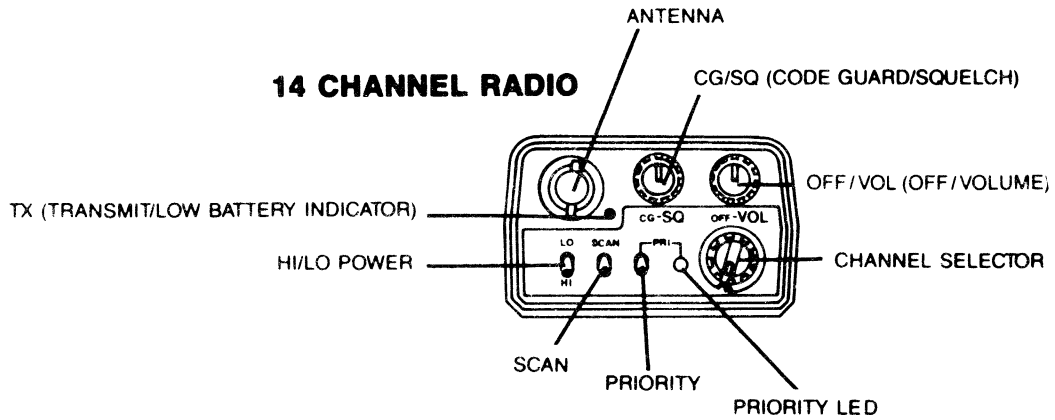
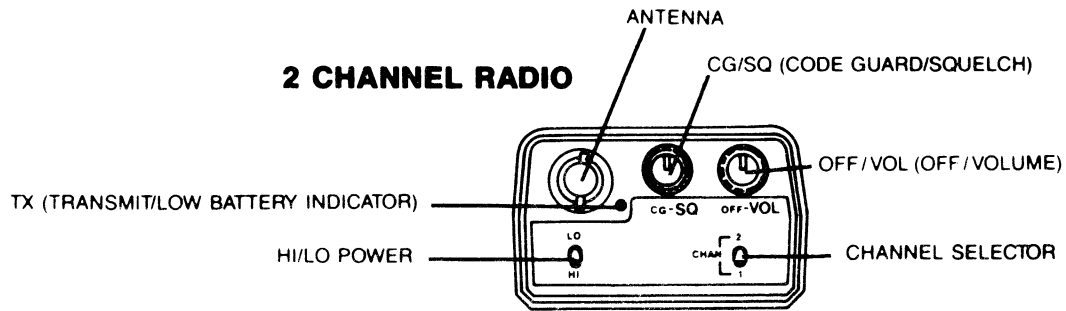

FIGURE 3-1 LPH 214/514 CONTROLS

SECTION IV THEORY OF OPERATION

4.1 INTRODUCTION

This section contains the theory of operation for the LPH series transceivers. Block diagrams are included in this section as Figure 4-1 and Figure 4-2 to aid in understanding the operation of the equipment. Schematic diagrams are found in Section V of this manual.

4.2 EQUIPMENT DESCRIPTION

The LPH 202, LPH 214, LPH 502, and LPH 514 are handheld VHF FM Transceivers operating in the 148-174 MHz band and are designed for use in domestic and foreign Land Mobile services. The LPH 202 and LPH 502 are two channel transceivers. The LPH 514 and LPH 214 are a 14 channel transceivers. All models are digitally synthesized and use a single crystal for frequency control. Usable channels are dealer programmable from 148 to 173.995MHz.

Controls include an On/Off/Volume control, Squelch Sensitivity, Channel Selector, and a HI/LO Power switch. In addition, the LPH 514 and the LPH 214 contain Scan and Priority select switches, a keyboard, and a liquid crystal display which displays channel and status information. Connectors are provided on the side of each unit for an external antenna, speaker, microphone, and programming and other related accessories.

4.3 THEORY OF OPERATION

Circuitry for the LPH series transceivers is comprised of four major circuits as follows:

The RECEIVER, which consists of the RF Amplifier, RF Filters, Mixer, IF Filters, Demodulation circuitry, squelch circuitry, and receiver audio circuitry.

The TRANSMITTER, which consists of the Power Amplifier, Harmonic Filter, Antenna Switch, and Power Control circuitry.

The SYNTHESIZER, which consists of the Voltage Controlled Oscillator (VCO), VCO Buffer, Prescaler, Prescaler Buffer, Reference Oscillator, Loop Filter, and the Synthesizer LSI.

The SYSTEMS AREA, which consists of the Microprocessor, Memory circuits, Code Guard™ circuitry, Transmitter Audio circuitry, Deviation Compensation circuitry, Front End Tuning circuitry, and the 5VDC and 8.3VDC Regulators.

4.3.1 RECEIVER

A. RF Preselectors

The first and second RF Preselectors are varactor tuned two pole filters which are essentially identical in structure. Coupling has been adjusted to allow the first filter to operate with low loss and the second filter to provide greater selectivity at a higher loss. Overall the preselectors exhibit a 3 dB bandwidth of 4.5 MHz and greater than 75 dB of rejection at the image frequency. The first preselector consists of L7, C35, CR4A, L8, C39 and CR4B. The second preselector consists of L9, C47, CR4C, L10, C51 and CR4D. CR4A through CR4D are a matched set of four varactor diodes. Tuning voltage for the preselectors is fed to the varactors through R33, R34, R44, and R45. The tuning voltage is generated digitally by the microprocessor and range shifted by I2A before application to the varactor diodes.

B. RF Amplifier

The RF Amplifier is a cascode amplifier providing 22 dB of RF gain. It is comprised of Q9 and Q10 and associated biasing circuitry.

C. Balanced Mixer

The Double Balanced Mixer is comprised of input transformer T3, diodes CR11 through CR14, and output transformer T1. Local oscillator injection is provided at the center tap of the primary of T1. The secondary of T1 is tuned to the IF frequency of 16.9 MHz.

D. IF Filter and IF Amplifier

The output of the mixer is fed to the first IF Filter, consisting of crystal filters FL4A and FL4B. This filter is 15 kHz wide centered at 16.9 MHz. The output of the first IF Filter is coupled to IF Amplifier Q2 and associated biasing circuitry through T2.

KING
LPH 202/214/502/514
VHF FM TRANSCEIVERS

E. AGC

High input power levels are detected by CR10 which in conjunction with Q5 causes the emitter voltage of Q10 to increase thereby reducing the receiver front end gain.

F. FM IF Subsystem

The FM IF Subsystem is built around I1, a multi-function integrated circuit. The following discussion describes the functions performed by I1.

The Second Local Oscillator consists of Y1, C19, and C20 connected to pins 1 and 2 of I1. The Second Mixer is contained in I1 and its output is filtered external to I1 by FL1, a 455 kHz ceramic filter. A five stage limiting amplifier within I1 provides most of the radio gain at 455 kHz. The FM signal is demodulated by ceramic discriminator FL2 and the audio output appears at pin 9 of I1. R24, R25, and C32 provide low pass filtering. The audio signal is split and then fed to the Audio Processing circuitry and the noise Squelch circuitry, which are described below.

G. Noise Squelch

A high pass filter for the detection of audio high frequency noise is provided by C28, C29, C30, C31, R23, R26, and R27 in conjunction with an amplifier contained within I1 at pins 10 and 11. The audio noise level is controlled by squelch depth adjustment R22 and fed to Noise Detector CR3 through C27. The resultant DC level on C26 represents the level of the noise in the audio, with R22 providing a noise gain adjustment. The DC noise indication is level shifted and buffered by Q19 and is detected by a Schmitt Trigger comprised of Q7, Q8, and associated circuitry, which provides some switching hysteresis. The output of the Schmitt Trigger is fed to inverting transistor Q18 and is subsequently routed to the System Board for further processing.

H. Audio Processing

The audio signal is fed to output pin 3 for signal processing options. The audio also passes through an audio filtering network comprised of I2C, I2D, and associated circuitry. This filtering network strips low frequency signalling tones from the audio. This filtered audio is also made available for options through output pin 4.

The filtered audio is routed through fast mute switch Q11 to I2C, which in conjunction with its associated circuitry, provides audio gain and the required FM de-emphasis characteristic. The output of the de-emphasis filter is made available for options (pin 8) and fed to gain control adjustment R58. The output of R58 is applied to I3 which provides sufficient audio power to drive the speaker. An additional input is provided at I3 for internally generated tones (pin 12).

I. Regulators

DC power to the receiver is controlled by the RX +5V supply generated on the Systems Board and Q12, Q13, and associated circuitry which use the presence of the RX +5V supply to switch the 10V A+ voltage to the rest of the receiver. In addition, a separate power switch consisting of Q4 and Q14 provides the ability to remove power from audio power amplifier I3 in response to a mute condition.

4.3.2 Transmitter

A. Power Amplifier (5 Watt Versions)

The 5 Watt Power Amplifier is comprised of four RF Amplifier stages: (1) the Low Level Amplifier, (2) the Predriver, (3) the Driver, and (4) the Final Amplifier.

The Low Level Amplifier Q7 is a Class A amplifier stage. At rated output power, it takes an RF signal at a nominal input level of +2 dBm and amplifies it to a nominal level of +10 dBm. In addition, this stage provides for output power reduction for low power operation by operating with a variable supply voltage.

Predriver Q8 is another Class A amplifier. At rated output power, it takes an RF signal at a nominal level of +10 dBm and amplifies it to a nominal level of +17.5 dBm. This stage also provides for output power reduction by operating with a variable supply voltage.

Drive Q9 is a Class C amplifier. Operating with a nominal gain of 10 dB, it takes the RF input signal provided by the Predriver and amplifies it to a nominal level of +27.5 dBm.

Final Amplifier Q11 is a Class C amplifier. Operating with a nominal gain of 10 dB, it takes the output of the Driver and amplifies it to a nominal level of +37.5 dBm (5.6 Watts).

KING
LPH 202/214/502/514
VHF FM TRANSCEIVERS

B. Power Amplifier (2 Watt Version)

The 2 watt power amplifier is comprised of three Rf amplifier stages:

- (1) The low Level Amplifier
- (2) The Driver
- (3) The Final Amplifier

The low level amplifier, Q4, is a class A amplifier stage. At rated output power, it takes an RF signal at a nominal input of +2 dBm and amplifies it to a nominal level of +14.0 dBm. In addition, this stage provides for output power reduction for low power operation by operating with a variable supply voltage.

The driver, Q5, is a class C amplifier. Q5 operates with a nominal gain of +12.0 dBm and takes the RF signal from Q4 and amplifies it to +26.0 dBm. This stage also provides for output power reduction for low power operation by operating with a variable supply voltage.

The final amplifier, Q6, is a class C amplifier. Q6 operates with a nominal gain of +7.8 dBm and amplifies the driver output to +33.8 dBm (2.4 watts).

C. Harmonic Filter and Antenna Switch

The Harmonic Filter is a 9 pole Chebyshev lowpass filter. Located on the Receiver Board, it attenuates harmonics created by the Power Amplifier to a level lower the 60 dB below the carrier power. Integral to the Harmonic Filter is the Antenna Switch which is comprised of two PIN diodes, CR1 and CR2 in a series-shunt configuration. In the Receive Mode (diodes off) the series diode, CR1 isolates the transmitter from the antenna while the shunt diode, CR2 now allows RF signals to pass freely to the receiver. In the Transmit Mode (diodes on) the series diode CR1, allows RF signals to pass freely from the transmitter to the antenna while the shunt diode CR2, is at the end of an effective quarter-wave match and blocks RF signals to the receiver. Losses in the Harmonic Filter reduce the power output to 5 Watts.

D. Power Control Circuitry

The power control circuitry consists of a current detector, an error amplifier, and two DC amplifier/inverters. The current detector consisting of R25, R15, R53, R55, CR8, and Q12 provides a DC voltage which is proportional to current drawn by the power amplifier. This voltage is presented to an error amplifier I5 where it is compared to a reference voltage determined by the power setting of the radio. The amplified error voltage is then fed to DC amplifier/inverters Q4 and Q5 which provide a control voltage to the low level amplifier Q7 and the predriver Q8. The control voltage adjusts the amplifier output power to reduce the error present at the input to the error amplifier to a small value, thus maintaining a constant current into the power amplifier. Since amplifier output power is proportional to current, the output power is maintained at a relatively constant value.

KING
LPH 202/214/502/514
VHF FM TRANSCEIVERS

4.3.3 SYNTHESIZER

A. Voltage Controlled Oscillator (VCO)

VCO Q1 generates the RF signal used for both the receiver and transmitter. Two frequency controlling varactors are used, one to set the carrier frequency (CR1) and one to modulate the carrier frequency during transmit (CR7). The oscillator frequency range is from 148-174 MHz in the Transmit Mode and 131.1-157.1 MHz in the Receive Mode (low side injection). The frequency range is covered using band switching with PIN diodes CR2 and CR3. CR3 is used to generate the 16.9 MHz offset from transmit to receive. CR2 is used to generate an approximate 12.6 MHz offset which increases the range of the oscillator. The following table describes the oscillator band switching:

Radio State	Carrier Frequency Range (MHz)	Oscillator Frequency Range (MHz)	Band Shift	RX/TX
RX	148.0 to 160.595	131.1 to 143.695	High	High
RX	160.6 to 174.0	143.7 to 157.1	Low	High
TX	148.0 to 160.595	148.0 to 160.595	High	Low
TX	160.6 to 174.0	160.6 to 174.0	Low	Low

B. VCO Buffer

VCO Buffer Q3 functions as both an amplifier and a buffer. It amplifies the RF signal provided by the VCO from a nominal level of -5 dBm to a nominal level of +5 dBm on receive and +2 dBm on transmit. The output of this stage supplies signal to the receiver, transmitter, and Prescaler Buffer.

C. Prescaler Buffer

Prescaler Buffer Q10 serves as a buffer between the Prescaler and the RF signal injection to the receiver and transmitter. It is the first device in the feedback path of the Synthesizer.

D. Prescaler

Prescaler I3 is the first divider in the feedback path of the synthesizer. Using emitter coupled logic, it divides the RF signal provided by the Prescaler Buffer to a frequency which can be processed by the following CMOS dividers. The Prescaler is of the dual modulus type which allows the divide value to be set by the Synthesizer LSI to either divide-by-40 (modulus control line high) or divide-by-41 (modulus control line low). This capability allows the channel spacing to be determined by the divided down reference frequency and not a multiple thereof.

E. Synthesizer LSI

Synthesizer I2 contains three programmable CMOS dividers, a sample-and-hold phase detector, and the amplifier for the reference oscillator. The first divider (divide-by-R) divides the reference oscillator down to a frequency which is used as a reference by the sample-and-hold phase detector. The second divider (divide-by-N) divides the output of the Prescaler down to a frequency which is equal to the divided down reference frequency when the loop is locked. The third divider (divide-by-A) controls the modulus control line of the Prescaler. The sample-and-hold phase detector provides a DC voltage through the Loop Filter to the VCO that is proportional to the phase error and adjusts the VCO frequency in a direction to maintain phase and therefore frequency lock between the divided down frequencies. R43, C46, C47 and R31 set the operating parameters of the sample and hold phase detector. R43 sets the bias on a constant current source to create a ramp voltage on C46 with a slope of approximately .60V/msec. C47 is the hold capacitor and R31 sets the bias on the DC output buffer pin 17.

KING
LPH 202/214/502/514
VHF FM TRANSCEIVERS

F. Reference Oscillator

The Reference Oscillator provides the frequency reference from which the receiver and transmitter injection signal are synthesized. The oscillator frequency is controlled by crystal Y1 which operates in the parallel resonant mode across an amplifier built into the Synthesizer LSI. This crystal is compensated to ± 5 ppm by a temperature compensating circuit consisting of Q13, RT1, R27, R32, R56, and R57. In addition, a method of modulation is provided to improve the synthesizer frequency response to low frequency modulation.

G. Loop Filter

The Loop Filter removes noise and unwanted frequency components from the output of the Sample-and-Hold Phase Detector which would otherwise modulate the VCO. In addition, it employs a multiple filter bandwidth design which allows fast response during frequency changes (such as in Channel Scan) without degrading the noise and spurious performance of the synthesizer during steady state receive or transmit conditions. The filter bandwidth is switched to a wide condition when the Latch Enable line pulses high for approximately 4 msec during a frequency change. This allows the new frequency to be reached quickly. When the Latch Enable line returns to the low state the filter bandwidth changes to a narrow condition and provides for good noise and spurious performance. Finally, different filter bandwidths are used from transmit to receive to provide better hum and noise performance on transmit and better response time on receive. This is accomplished by changing the filter bandwidth to a narrower value when the RX/TX- lines goes low during transmit.

4.3.4 SYSTEMS AREA

A. Microprocessor

Microprocessor I4 takes inputs from user keys (SCAN, PTT, etc) and controls radio functions such as loading the synthesizer, adjusting the deviation, receiver tuning, and time-out functions. A 4 MHz crystal at pins 42 and 43 forms the master oscillator.

B. EEPROM

EEPROM I3 stores user specific parameters such as frequencies, time out timer length, scan list, etc. To reduce standby power, the EEPROM is turned on whenever pin 13 of I1 is brought low. The serial data bus (DATA IN, DATA OUT, and CLOCK) is used to read/write to the EEPROM.

C. 5V Regulator and Low Voltage Reset

5V Regulator I4 is set by the voltage difference between the output and the adjust. R22, R100 and R23 form a voltage divider to keep this difference at 1.25 VDC regardless of the load on the output line. When battery voltage falls below 8.5 VDC, zener diode CR7 turns off, which turns Q13 off. This turns Q2 on, pulling the RESET line low and resetting the microprocessor.

D. 8.3V Supply

Q4 and I5B form a feedback loop that translates regulated 5 VDC to 8.3 VDC. R65 and R66 divide down 8.3 VDC to 5 VDC which is compared and corrected by the op amp. Whenever the radio is not in Battery Saver Mode, synthesizer 8V is turned on by Q11. CR8 and Q14 form a logic OR gate whenever pin 15 (TX) or pin 14 (RX) are in their active state.

E. Transmit Audio

Electret microphone audio is amplified about 3 times and buffered by I5D. I6A hard limits the audio to about 3Vp-p. I5C forms a summing buffer, bringing together any CTCSS via R72 and the microphone audio via R53. A three pole low pass filter with a cutoff near 3 kHz follows the summing buffer. The output is fed to the TX/SYNTH board as deviation compensated audio (see below) and direct reference modulation.

F. Deviation Compensation and Front End Tuning

On transmit, network R42, R43, R44, and R45 form a variable resistor that becomes a voltage divider with R41, controlling the peak voltage (deviation) to the transmitter board. As the transmit frequency increases, less voltage is needed at the VCO, so a lower resistance (more conductance in parallel) is set by the microprocessor.

On receive, network R8, R13, R14, R15, R16 and R90 form a Digital-to-Analog Converter that sets a voltage for controlling the receiver front end tuning. As the receiver frequency increases, the voltage increases.

**KING
LPH 202/214/502/514
VHF FM TRANSCEIVERS**

G. CTCSS Filters

During transmit, the Digital-to-Analog Converter network is used to generate the proper CTCSS waveform. This is coupled into a 3 pole low pass filter via R85 with a cutoff near 250 Hz. R72 sets the deviation to about 750 Hz.

On receive, discriminator audio is fed into a 5 pole low pass filter followed by limiter I2B. CR 3 is used to speed up charging C4 whenever a major DC change occurs. The hard limited waveform is further processed by the microprocessor to determine if the proper CTCSS was sent.

4.3.5 PROGRAMMABLE FREQUENCY INCREMENTS

Frequencies can be programmed from 148.00 to 173.995MHz in increments of 5KHz for 2141 and 5141 models and in 12.5KHz increments for 2142 and 5142 models.

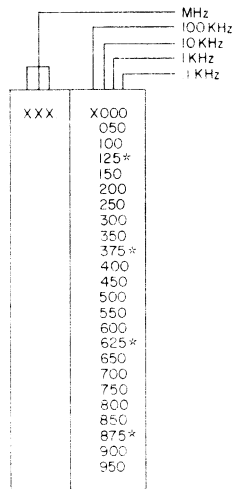

* AVAILABLE ON 2142 AND 5142 MODELS ONLY

**TABLE 4-1 FREQUENCY INCREMENTS
(Dwg No 696-0775-10 Rev 0)**

KING
LPH 202/214/502/514
VHF FM TRANSCEIVERS

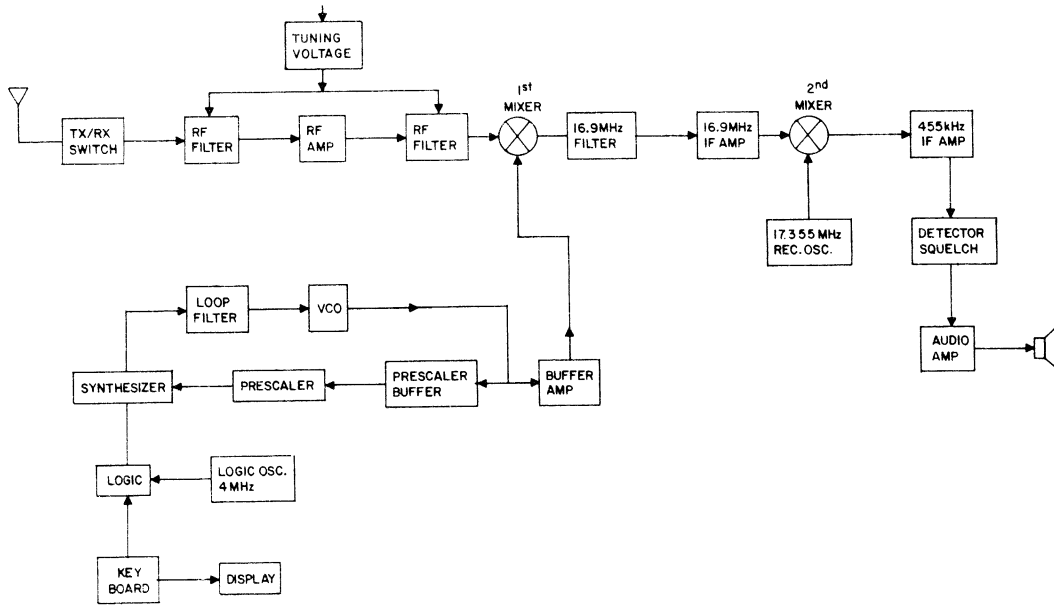

FIGURE 4-1 LPH RECEIVE BLOCK DIAGRAM
(Dwg No 696-0775-06 Rev 0)

This
Page
Blank

Page 4-8

KING
LPH 202/214/502/514
VHF FM TRANSCEIVERS

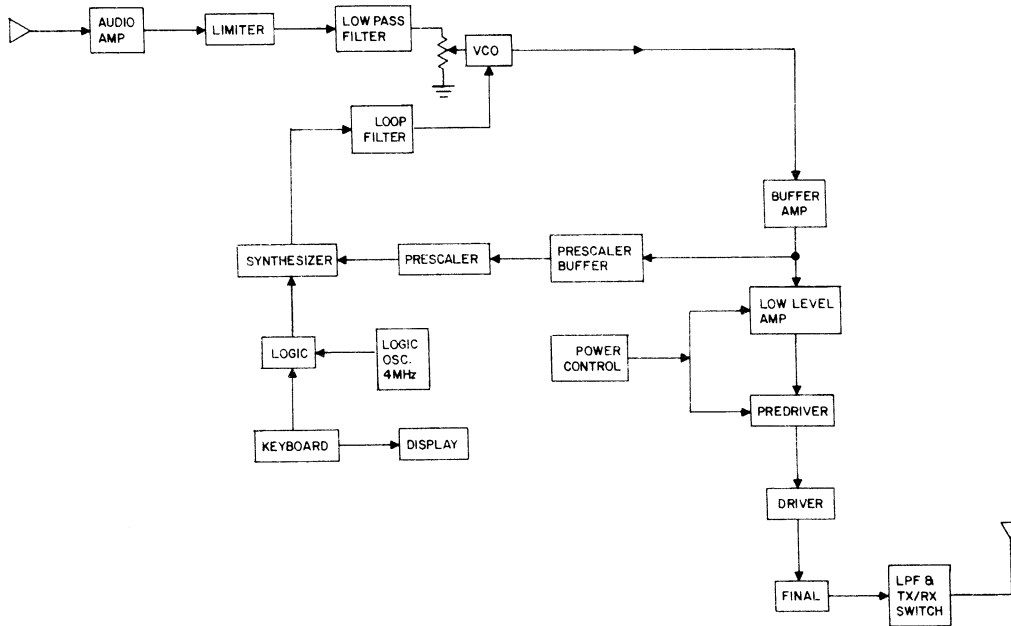

FIGURE 4-2 LPH TRANSMIT BLOCK DIAGRAM
(Dwg No 696-0775-07 Rev 0)